

Active Birth Pools

Built to last for decades

Guaranteed for life



ACTIVE
BIRTHPOOLS

We helped pioneer the use of water for labour and birth by designing the water birth pools that made this revolution in maternity care possible.

Our story is one of change, innovation and development.

In the mid-1980's we worked closely with midwives, mothers, obstetricians and health and safety experts to develop the world's first specially designed, hospital grade water birth pool.

Since then we've continued to evolve our designs, upgrade the materials we use and improve our manufacturing and engineering capabilities to produce water birth pools that are safer and better meet the needs of all end users.

Judges at Building Better Healthcare Awards described our water birth pools as, "The pinnacle of water birth pool development and an incomparable combination of design, materials and manufacturing"

Our mission is to create intelligently designed water birth pools that improve the quality of birth for mothers and midwives in the safest, most practical and sustainable way.

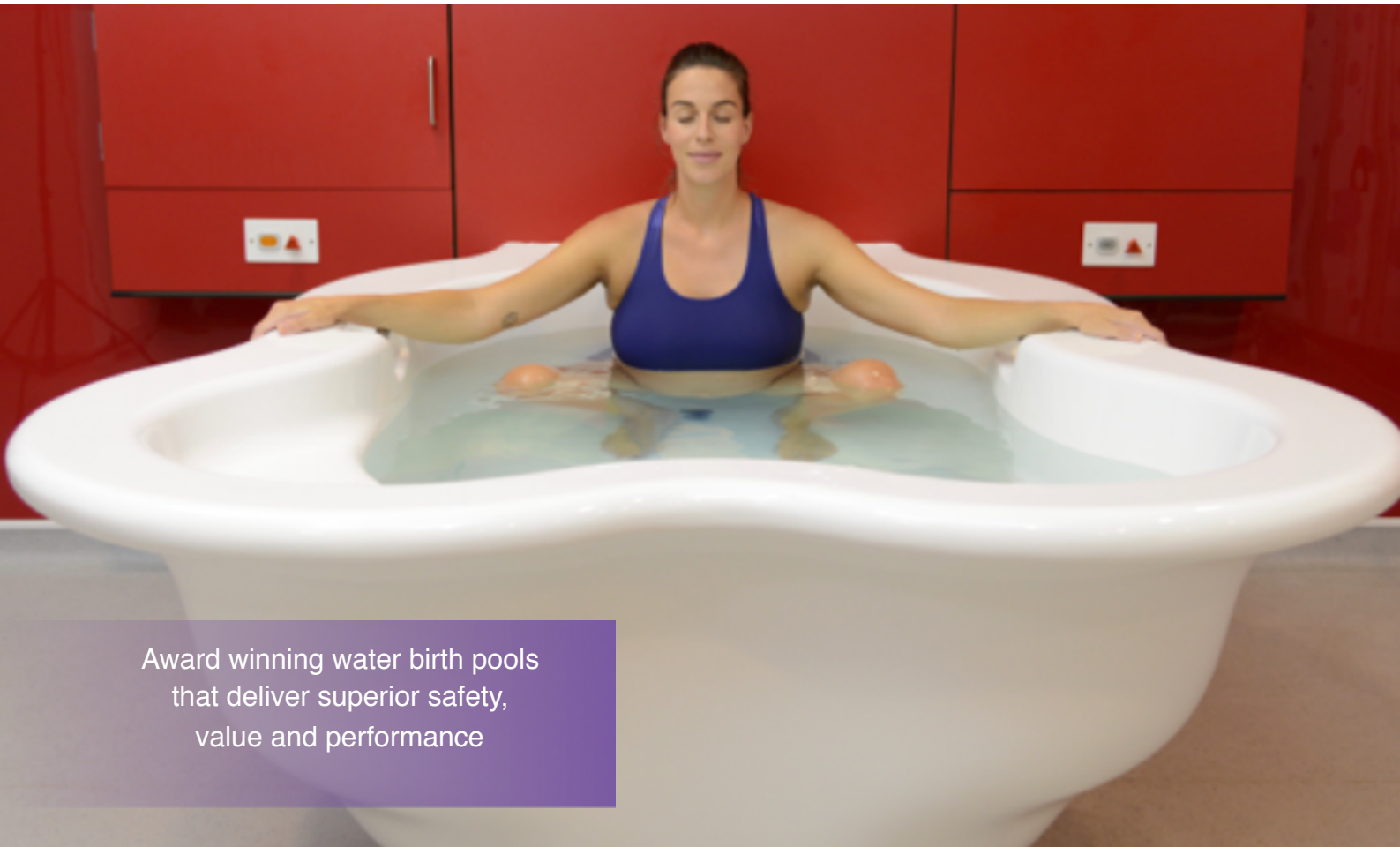

Award winning water birth pools that deliver superior safety, value and performance

If you're looking for a water birth pool we're uniquely qualified to be of service

We've achieved success by keeping things simple and focusing on our core principles of Safety, Value and Performance.

A passion for excellence and commitment to supporting midwives and helping mothers have a better experience of labour and birth defines our approach.

Our unrivalled knowledge and wealth of experience enable us to provide water birth pools that minimise risk, optimise results and maximise value.

We've supplied thousands of water birth pools to hundreds of hospitals world-wide over the past 35 years and worked with end-users, specialists and manufacturers to develop and improve our capabilities.

Active Birth Pools are made by hand to order in England by highly skilled craftsmen who take great pride in their work and are dedicated to excellence.

Clients choose us because they know that our water birth pools can be relied on to deliver superior performance, unparalleled safety and unbeatable sustainability.

We stand behind our water birth pools 100% and guarantee that if the need for support or after sales services arises we will be there to help wherever you are.



Our water birth pools are built to last for decades and guaranteed for life

We have carefully considered the dynamics at play when mothers and midwives interact with each other and the pool, and employed evidence based, user-centred ergonomic design principles to develop water birth pools that are widely regarded as the most comfortable, practical and easy-to-use.



Active Birth Pools optimise the benefits of immersion in warm water to give mothers a greater possibility of experiencing physiological labour and natural birth.



Because midwives work with our pools on a daily basis we've considered their comfort and safety paramount. They tell us our pools are 'fab' and a pleasure to use.



Mothers say that they love our pools because they are so comfortable and supportive, and have plenty of room to move and find the most beneficial positions.



Freedom of movement combined with the relaxing effects of warm water, and the release of oxytocin increases the possibility of physiological labour and birth.

Our pools are designed with complex, sensuous forms that make them appealing both physically and psychologically.

Form is based on function and pared down to the essence of aesthetic utility.

There is a reason for every shape, every curve and every form.



Midwives find our pools extremely comfortable. They sit naturally with their arms resting on the wide rim and their legs under the rim, just like you do at a desk.



Mothers relate to our pools instinctively using the seats and wide rims to rest on, and for support in the positions natural to labour and birth.



A defining feature of our pools is the extra-wide, wrap-around bullnose shaped rim which mothers can grab onto from anywhere in the pool for support in upright positions.



In 1995 we worked with a health service ergonomist to improve the design of our pools. This work led to innovations that made our pools safer and more user-friendly.

Ficore® - the key to the success of our pools



Ficore®, a proprietary material with unique qualities enables us to produce water birth pools that are more beautiful, practical and utilitarian, as well as safer, more economical and sustainable when compared to other birth pools on the market.

FICORE is a solid composite resin not a laminate or bonding. It's composition and method of processing permit more sharply defined details such as tighter radii and curves. It cannot disintegrate or come apart in the way that fibreglass or acrylic pools can.

Water birth pools made from Ficore® have many advantages:

1. Highly polished finish is ultra-smooth, tactile and warm to the touch
2. Resistant to bacteria, cleaning agents and harsh disinfectants
3. Superior heat retention (.7 degrees heat loss per hour)
4. Stronger, more durable and easily repaired like new
5. Less slippery and easy to clean
6. Highest water safety and hygiene standards
7. Highly sustainable, longer life and better performance for your investment

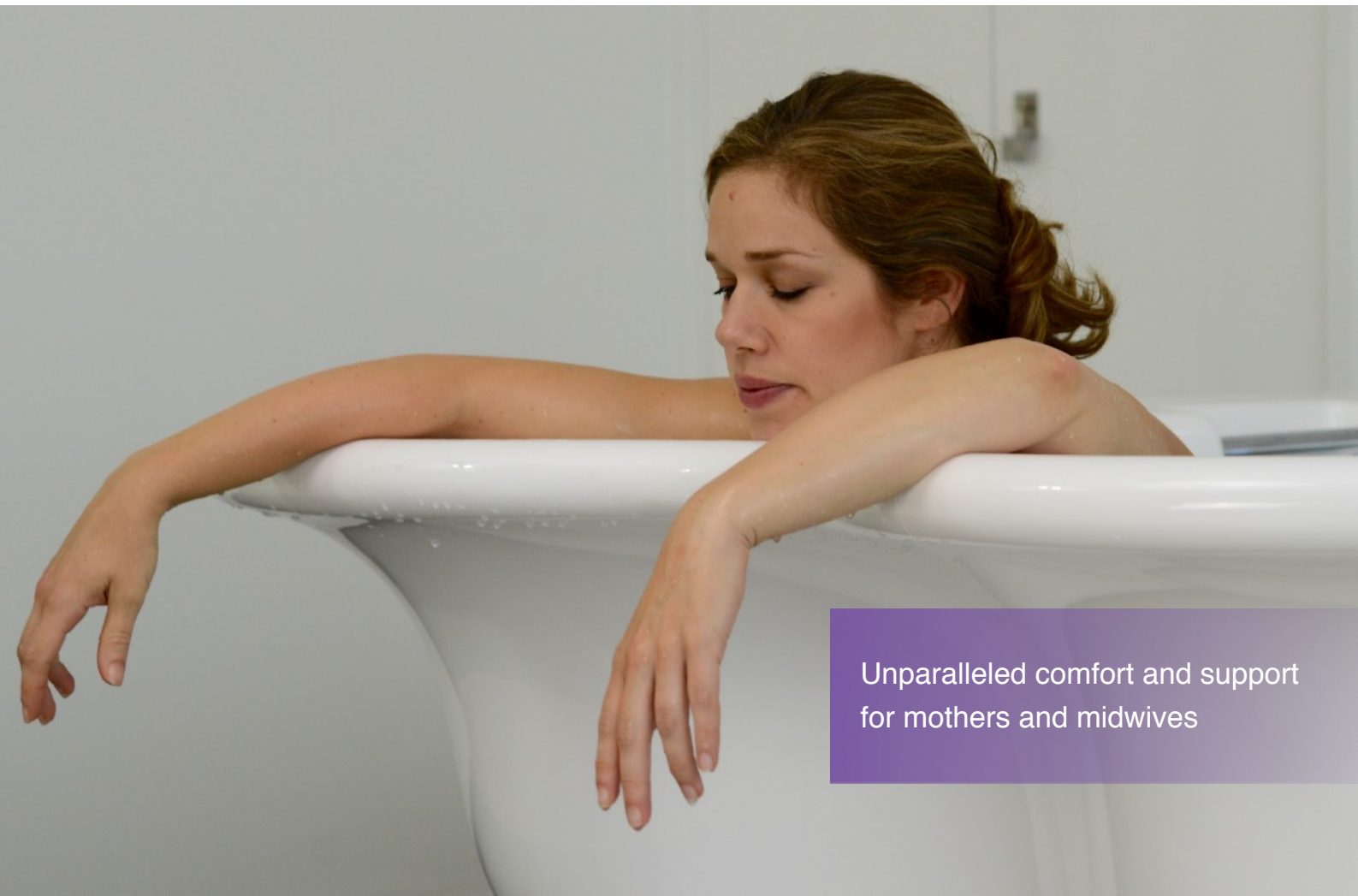

Unparalleled comfort and support
for mothers and midwives

Ficore® composite resin is a material of extra-ordinary properties unique to Active Birth Pools that was developed to minimise problems associated with other materials used in the manufacture of water birth pools.

Ficore is a composite of 8 different elements chemically fused during manufacturing, then heat cured at high temperature to create a material that is light in weight but 'heavy' in performance.

Seamless, one-piece fabrication in Ficore® has enabled us to reinvent the water birth pool and offer you a pool that delivers superior performance, greater value and unparalleled safety.

Due to Ficore's high insulation factor and double-wall construction our birthing pools maintain water temperature up to 7 x longer than other water birth pools.

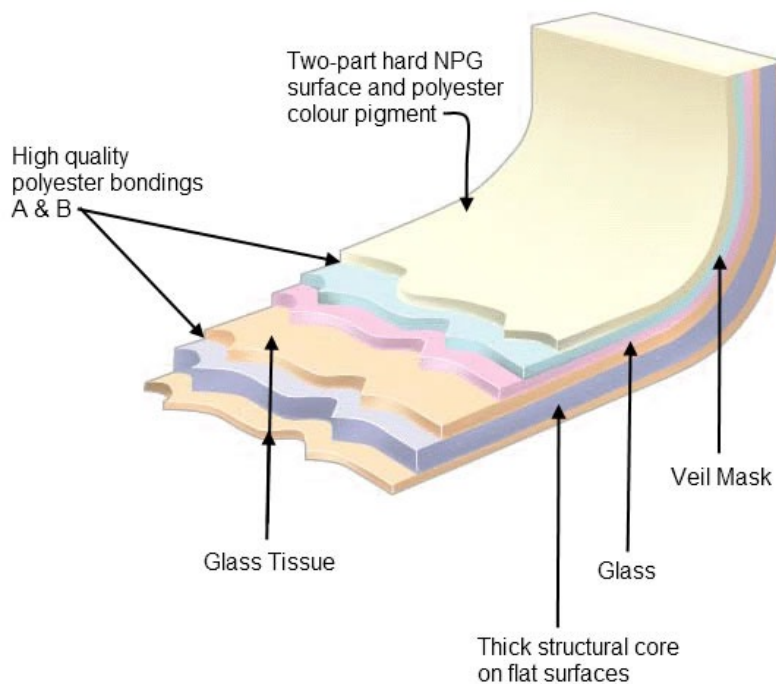

Ficore® is approved by:

- Lloyd's Register of Shipping for use in the construction of craft under their survey
- Wine Laboratories Limited for long term storage of high alcohol wines and spirits
- Water Research Council and Water Bylaws Advisory Service for long term storage



Unique structural and engineering advantages

Water birth pools fabricated in Ficore are stronger, heavier and much more rigid than birthing pools that are made from fibreglass or acrylic. Active Birth Pools have an extremely high degree of structural integrity and will not flex, buckle, bow, or change shape under pressure.

Highly polished, ultra-smooth finish

The surface is isophthalic neo-pentyl-glycol which makes them 50% harder in comparison with birthing pools produced from other materials. The finish is highly polished, ultra-smooth, tactile and warm to the touch which makes it appealing both physically and psychologically.

Slip Resistance

Compared to other materials Ficore® is significantly less slippery. This reduces the risk of injury mothers and midwives and gives our water birth pools a crucial advantage.

Durability

Water Birth Pools made from Ficore composite have a life expectancy in excess of 25 years. This makes Active Birth Pools considerably more sustainable when compared to the 7-10 year life expectancy that other water birth pools on the market have.



Water Safety and Hygiene



The potential for water birth pools to be both a habitat and a delivery medium for harmful bacteria such as Pseudomonas and Legionella is well known. We completely understand this and produce pools made from a superior material with intelligent design and a range of innovations that negate risk and deliver safer birthing environments.



Minimal surface mounted fittings optimise hygiene and give mothers and midwives unobstructed movement around the rim.



Seamless, one-piece construction in Ficore® improves water safety and hygiene by denying bacteria the environment to grow.



Our stainless steel handgrips are bonded directly into the fabric of the pool rather than rim mounted to negate infection control risks.



The smooth surface and organically shaped form improves hygiene by facilitating more effective cleaning and eliminating “dirt traps”.

Safety and Manual Handling



A deep and abiding understanding of the physicality of labour and birth, coupled with an appreciation of how midwives need to perform while attending mothers has enabled us to design water birth pools that resolve the safety and manual handling risks that are associated with water birth.



Midwives have safe, practical means to carry out emergency evacuations and monitor mothers. Portable hoists can also be used.



Mothers use the extra-wide rim sit on and swivel into the pool staying grounded at all times for a safe transition from land to water.



Midwives report better results and greater job satisfaction. They love our pools because they're practical, comfortable and easy to work with.



Features such as the sculpted concave surround and extra-wide rim improve the midwives posture and enables them to be closer to the mother.

Active II Water Birth Pool



Judges at the Building Better Healthcare awards said that the original Active Birth Pool was an incomparable combination of intelligent design, superior materials and state-of-the-art manufacturing.

The latest advancements in design, material and engineering take the new model of this award winning water birth pool to new levels of safety, usability and end-user satisfaction.



Specifications

Length:	1965mm
Width:	1650mm
Height:	770mm
Depth:	640mm
Weight (empty):	100kg
Capacity:	560 litres
Material:	Ficore® composite
Guarantee:	Lifetime

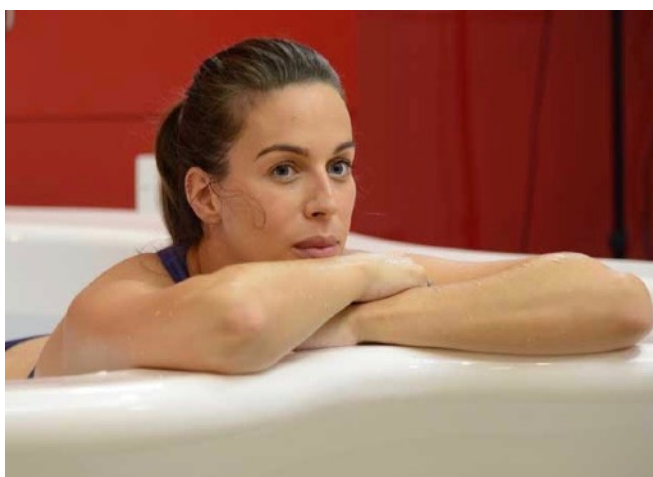
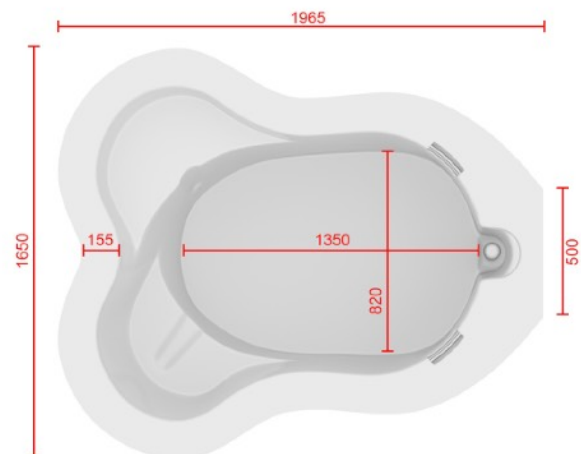

Active II Water Birth Pool

ACTIVE
BIRTHPOOLS

Multi-colour Lighting and Blue-tooth Sound create a conducive atmosphere for physiological labour and natural birth

The organic shape of this luxurious pool is appealing both physically and psychologically

Seamless one-piece fabrication in Ficore composite denies bacteria a place to grow

The distinctive keyhole shape channel protects mothers from hitting their heads on the spout

Recessed hand grips do not obstruct movement around the rim and provide support in upright postures

Superior material highly resistant to bacteria and chemicals

The highly polished surface is ultra-smooth, less slippery and warm to the touch

The wide wrap-around rim maximises comfort and usability for mothers and midwives

Simple and safe for mothers to get in and out of the pool

Portable hoist compatible

There is maximum space under the rim for midwives to sit closely in comfort

The bull-nose rim provides a firm hand hold for mothers in all positions

The Safety Seat facilitates monitoring and emergency evacuations

Optimum space, and depth and give mothers complete freedom of movement

The Labour Support Seat provides support in upright positions and a place for mothers to rest and welcome their baby



Active II/360 Water Birth Pool

Originally designed with the help of a health service ergonomist and midwives in 1995 this large, luxurious birthing pool will help you create a world-class facility for labour and birth in water.

We've transformed the Active II into a freestanding pool and added a specially designed Water Column to maximise hygiene, water safety and provide support for mothers and midwives.



Specifications

Length:	1965mm
Width:	1650mm
Height:	770mm
Depth:	640mm
Weight (empty):	100kg
Capacity:	560 litres
Material:	Ficore® composite
Guarantee:	Lifetime

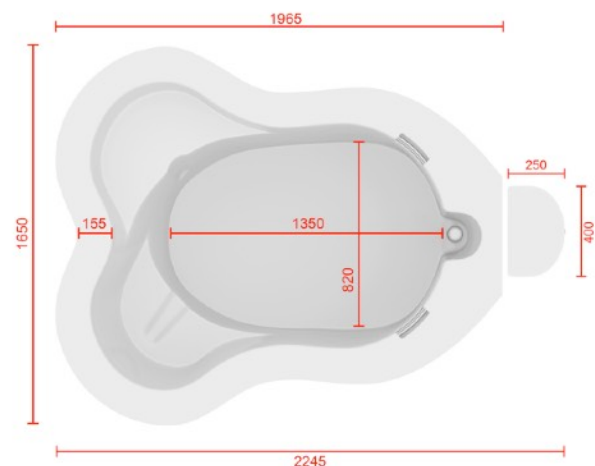

Active II/360 Water Birth Pool

ACTIVE
BIRTHPOOLS

The bull-nose shaped rim provides firm hand-hold for support in upright positions

Multi-colour LED lighting and Bluetooth sound system allow mothers to personalise the ambiance of the room

The sturdy column provides support for upright birth positions and a plinth for midwives to lean on

The keyhole shape channel in the back rim protects mothers from hitting their head on the spout

The recessed hand grips provide the ideal support for upright positions such as squatting

The wide rim, grab rail and step unit make it simple and safe for mothers to get in and out of the pool

Designed to safeguard mothers and midwives from risk of injury and cross infection

The rounded, bull nose-shaped rim provides dynamic support for upright positions

Specialised material makes our pools less slippery, tactile and warm to the touch

This large, luxurious pool gives mothers and midwives complete freedom of movement both in and around the pool

The extra hard, dense material is highly resistant to damage, bacteria and disinfectants

Midwives sit naturally, in comfort with their legs under the pool and arms resting on the extra-wide rim

The concave, cutaway surround enables portable hoists to be utilised for emergency evacuations

The innovative Safety Seat provides support for mothers and gives midwives safe, practical options for monitoring, and emergency evacuations

Mothers have optimum space, depth and support to gain maximum benefit from water immersion

The unique Labour Support Seat is tilted forward to encourage the pelvis to spread and the birth canal to open.



Venus II Water Birth Pool

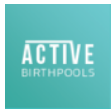

This iconic mid-size, water birth pool was originally developed in mid-1980's with the help of mothers, midwives, obstetricians, manual handling and infection control experts.

Millions of women around the world have benefited from using this simple pool of water to have better experience of labour and birth.

The Venus II is a quantum leap forward taking the original model to new levels of safety, value and performance.



Specifications

Length:	2015mm
Width:	1350mm
Height:	770mm
Depth:	640mm
Weight (empty):	90kg
Capacity:	510 litres
Material:	Ficore® composite
Guarantee:	Lifetime

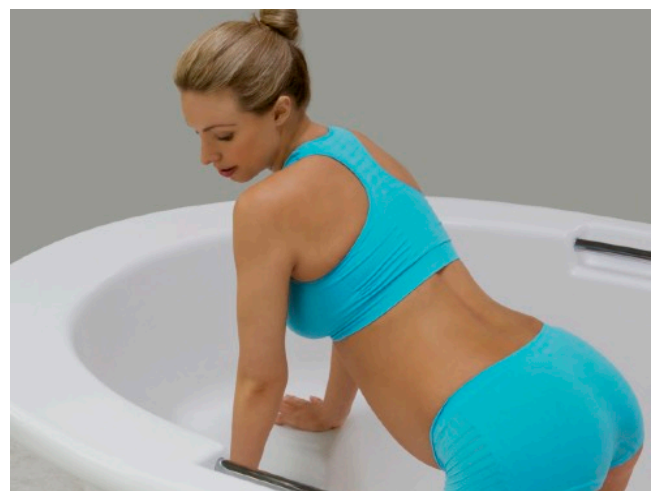
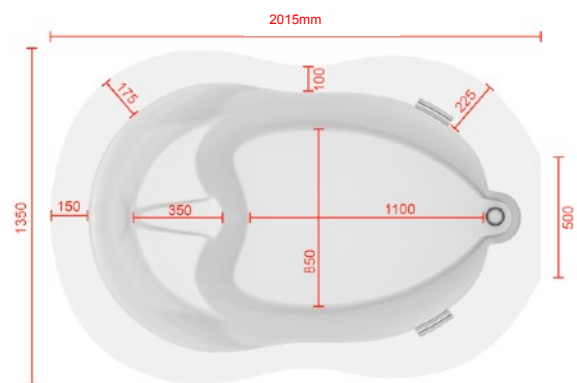

Venus II Water Birth Pool

ACTIVE
BIRTHPOOLS

Intelligently designed to allow mothers to move naturally and instinctively to find the most beneficial positions

Purpose designed drainage with pop-up waste and rim-mounted control

The distinctive keyhole shape channel in the back rim protects mothers from hitting their heads on the spout

Recessed hand grips give mothers support in upright positions and help make squatting easier

Multi-Colour LED Lighting and Bluetooth Sound enable mothers to control the ambiance of the room

Optimum space and depth encourage mothers to move freely and gain maximum benefit from immersion in water

The bull-nose shape rim gives mothers a firm handhold to grab onto from anywhere in the pool

Safe, practical options for emergency evacuations with or without portable hoists

Mothers are actively supported as they move around the pool to find the most comfortable positions

The Labour Support Seat has a distinctive groove down the middle which allows the coccyx to float freely and not impinge the birth canal

Extra-wide rim and step unit make it simple and safe for mothers to get in and out of the pool

The highly polished surface is ultra-smooth, less slippery, tactile and warm to the touch

The ultra-hard surface is less slippery and highly resistant to bacteria and chemicals

The Skirting Panel hugs the pool to create space under the rim for midwives to work closely in comfort

Seamless one-piece fabrication in Ficore composite makes it easier to clean and denies bacteria the environment they need to propagate



Venus 360 Water Birth Pool

The mid-size Venus 360 is the perfect choice for rooms where end users want to have the pool away from the wall.

It combines intelligent design with superior materials and build quality to create a birthing pool that delivers superior value, outstanding performance, and unparalleled safety.

We've increased access around the back of the pool and developed the Water Column to create a birth pool that is safer and more user-friendly.



Specifications

Length:	2065mm
Width:	1350mm
Height:	770mm
Depth:	640mm
Weight (empty):	90kg
Capacity:	510 litres
Material:	Ficore® composite
Guarantee:	Lifetime

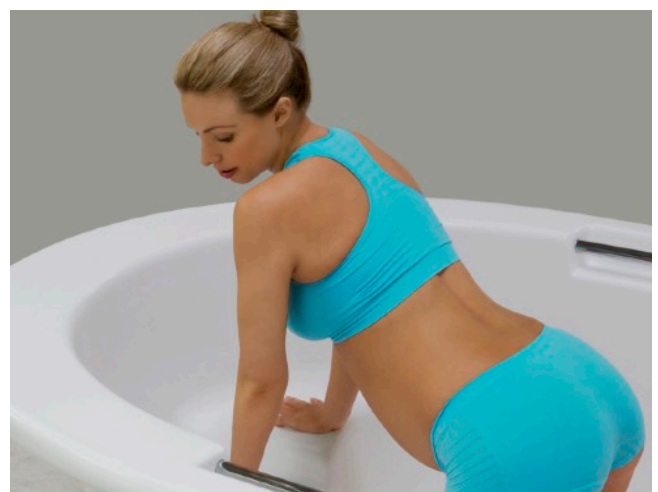
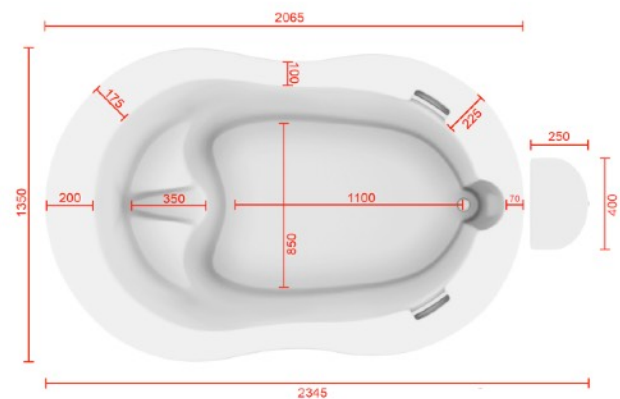

Venus 360 Water Birth Pool

ACTIVE
BIRTHPOOLS

Multi-colour lighting and Blue-tooth sound enable mothers to personalise the ambience of the room

The Water Column separates the plumbing from the pool to maximise hygiene and water safety

The 'keyhole' shaped channel protects the mother from hitting her head on the spout

The recessed hand grips are bonded into fabric of the pool to deny bacteria to a place to grow

The extra-wide rim, grab rail and step unit make it easy for mothers get in and out of the pool

The combination of double wall construction and ultra-dense material reduces heat loss to .7 degrees per hour

Provides freedom of movement for mothers and midwives to move naturally both in and around the pool

Seamless one-piece construction in Ficore composite makes the pool more durable and easier to clean

The Labour support Seat encourages optimal positioning and gives mothers a place to rest and welcome their baby

Mothers use the extra-wide rim to rest on and to safely enter and leave the pool

Easier to clean and maintain and can be easily repaired on site like new if damaged

The concave, cut-away surround makes it easier and more comfortable for midwives to be close to the mother

Optimal space and depth for mothers to move and find most beneficial positions

The bull-nose shaped rim provides mothers with support in the wide range of postures natural to labour and birth



Princess II Water Birth Pool



The compact yet surprisingly Princess II is the perfect choice for rooms with limited space.

This perfectly formed gem of a pool now features a specially designed labour seat to support mothers in upright postures and give them a place to rest and welcome their baby.

Though we've pared things down to the minimum to create this highly utilitarian pool we made sure to include all of the essentials that make our pools stand out from the rest.



Specifications

Length:	1600mm
Width:	1100mm
Height:	770mm
Depth:	640mm
Weight (empty):	70kg
Capacity:	425 litres
Material:	Ficore® composite
Guarantee:	Lifetime

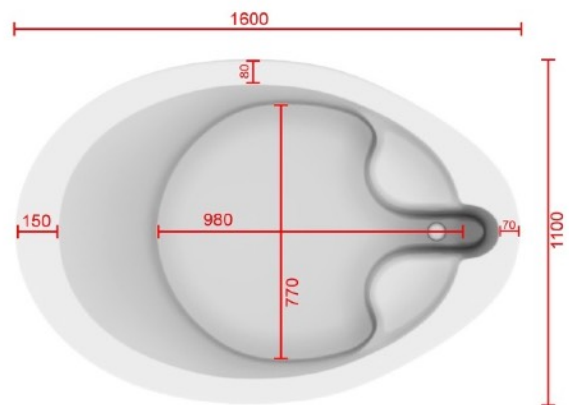

Princess II Water Birth Pool

ACTIVE
BIRTHPOOLS

Multi-colour LED Lighting System gives mothers six ambient colours to choose from

The ultra-hard material is less slippery and more resistant to bacterial and cleansing agents

The key-hole shape channel in the rim protects mothers from hitting their head on the spout

Bluetooth Sound System with integral speakers for mothers to play music of their choice

The Labour Support Seat provides support in upright positions and a place for mothers to rest

Bespoke drainage system with pop-up waste and rim mounted control

Midwives sit in comfort with their legs under the pool and arms resting on the extra-wide rim

The extra-wide front rim makes it easy for mothers to get in and out of the pool

The bull-nose shape wrap-around rim provides mothers and midwives with maximum comfort and support

The Lumbar Support provides exceptional support for mothers in squatting positions

Safe, practical options to facilitate emergency evacuation with or without a portable hoist

There's plenty of room for mothers to move freely to gain maximum benefit from water immersion



Princess 360 Water Birth Pool

With a footprint of just 1.76m² the freestanding Princess 360 is ideal for rooms where space is at a premium.

Mothers and midwives benefit from complete freedom of movement both in and around the pool and will appreciate the comfort and support they receive.

The Princess 360 is perfectly formed, surprisingly spacious and delivers the same performance that our larger pools do.



Specifications

Length:	1600mm
Width:	1100mm
Height:	770mm
Depth:	640mm
Weight (empty):	70kg
Capacity:	450 litres
Material:	Ficore® composite
Guarantee:	Lifetime

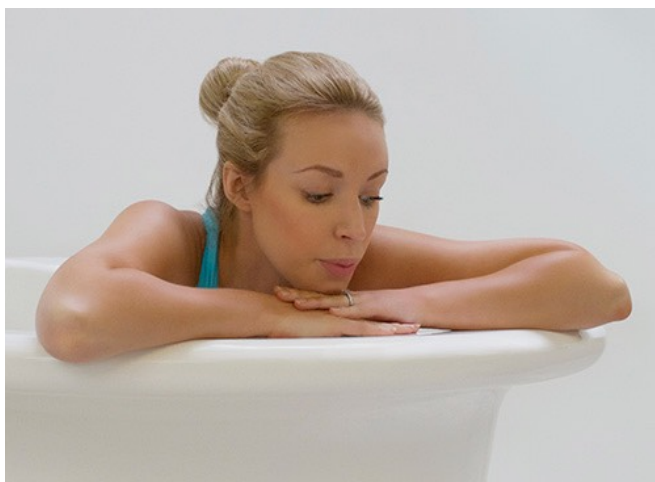
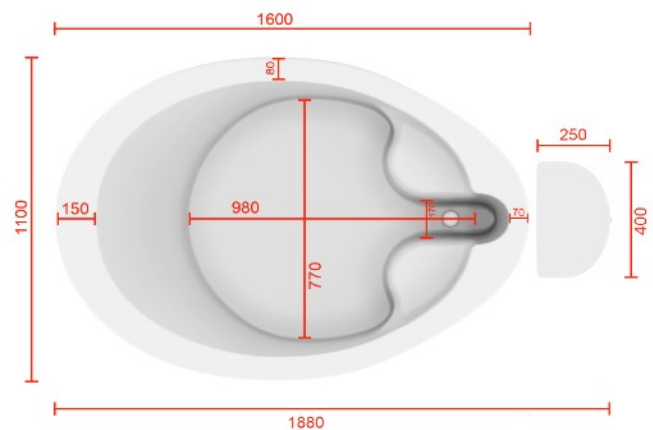

Princess 360 Water Birth Pool

ACTIVE
BIRTHPOOLS

The Labour Support Seat encourages the pelvis to open and provides support in upright postures

The Water Column separates the plumbing from the pool to guarantee highest level of hygiene and water safety

The keyhole shaped channel in the rim protects mothers from hitting their head on the spout

Integral LED Lighting and Bluetooth Sound allow mothers to personalise the ambiance of the room

The step unit and grab rail help make it easy for mothers to safely get in and out of the pool

The wrap-around rim provides support for mothers in the full range of positions natural to labour and birth

The highly polished finish is less slippery, super smooth, tactile and warm to the touch

360 degrees of movement around and in the pool for mothers and midwives

The Lumbar Support provides comfort and support for mothers in upright postures like squatting

High density and superior strength minimise heat loss and make our pools more durable and economical

Though compact, the Princess Pool is surprisingly spacious for mothers to move freely in comfort

Designed to safely facilitate emergency evacuations with or without a portable hoist

Easy to clean, resistant to bacteria and repairable on site, like new if damaged

There's plenty of space under the rim for midwives to get close to the mother in comfort



Water Column

The highly utilitarian, sleek design of the Water Column complements the aesthetic of our pools and provides a safe, practical solution for installing plumbing and for mounting fixtures and fittings.

This strong, sturdy column is ideal for mothers to hold onto when getting in and out of the pool and to use for support in upright and standing positions during labour.

Its the perfect height for midwives to sit behind and lean on to rest while attending births. They can use the gently sloping top for support or as a surface for writing up notes.

N.B. The Water Column is supplied without plumbing or fittings. Shown: Rada T3 Bath/Shower Tap, Rada 150mm Spout and Grohe Handheld shower

Specifications

Depth:	250mm
Width:	400mm
Height:	1100mm
Material:	Ficore® composite
Guarantee:	10 years



Step Unit

Over the past 35 years we've worked with safety and design experts to devise a simple, but sophisticated method for mothers to safely enter and leave our pools.

Fundamental to the success of our approach is the extra wide rim which mothers simply sit on to swivel around into the water.

The sturdy step unit gives mothers a crucial height advantage that allows them to sit on the rim, no matter how tall they are.

Manual Handling experts have emphatically told us they do not want mothers in strong labour climbing up steps to get into a pool.

With our system mothers stay safe and grounded at all times and are not exposed to unnecessary risk.

Specifications

Length:	455mm
Width:	300mm
Height:	150mm
Weight:	4kg
Material:	Vitrine® composite
Guarantee:	2 years



Light & Sound

Studies have proven that light and sound play a significant role in the creation of a better birthing environment.

The integral Multi-colour LED lighting and Blue-tooth Sound systems allow mothers to personalise the ambiance of the room to create a relaxing atmosphere that is more conducive to physiological labour and natural birth.

Our underwater lighting illuminates the room with a soft ambient glow and makes it easier for midwives to see into the pool.

The integral sound system has two high quality speakers. You simply connect to it with your bluetooth device to turn the pool into a sound stage.

The Multi-colour LED lighting system gives mothers a selection of six ambient colours to choose from.

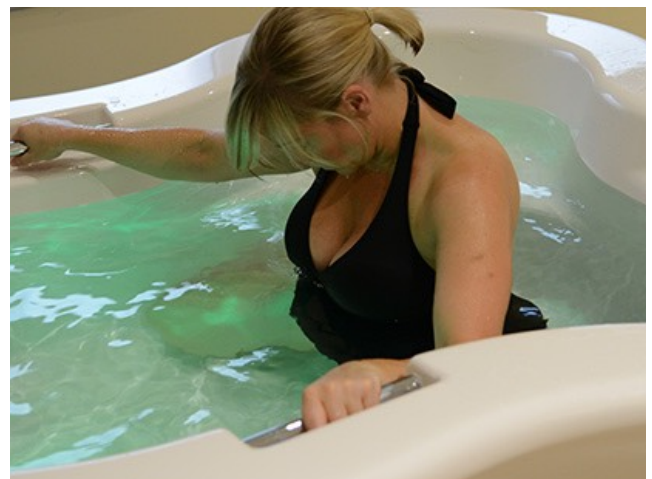

References and Testimonials



"I have been working with Keith for many years as a distributor for Active Birth Pools in the US. He is an individual of great integrity and trustworthiness and believes in continuously improving his already perfect line of birthing pools. He is a true pioneer and has sharpened his pencil once again to improve upon what I thought was the perfect birth pool. With the new Active II and Venus II pools now in production, I guess you really can improve upon perfection! I'm proud to be a part of the Active Birth Pools world-wide family."

Tim Johnson-Grass - Family Health & Birth Center co-owner and Distributor of Birthing Pools



"When asked about the history of birthing pools in hospitals, I mention the day when Keith Brainin realised that special bath tubs might be designed and commercialised to meet the needs of labouring women."

Michel Odent – water birth pioneer, obstetrician and author



"The best pools for the Birth Olympics hands down! Makes you want to have another baby just to experience it again! I've both delivered and caught babies in your pool. They're comfortable, provide stability, are simple to clean and midwife and dad friendly. Just a dream all the way around."

Alicia Witt Director BirthPros.com, CEO at ArizonaMidwife.com



"Not only are they gloriously spacious and inviting, they are made to the highest specifications and considerations to maximise comfort and safety. In short, they are second to none!"

Sheena Byrom OBE - Activist, Midwife, Speaker and Author



"Keith is very passionate and dedicated towards improving water births. We have worked closely together on multiple projects and Keith is always very professional. The pools are designed for the women and midwives that prefer the active birth and built to last forever. The pools are truly one of a kind!"

Brian Vester - Product Manager and Partner at GM Medical

References and Testimonials

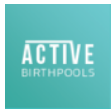

"I've worked with Keith Brainin as an international trade advisor for many years. When it comes to water birth pools he is extremely experienced and knowledgeable. The testimonials he has received from professionals and mothers are evidence of his dedication to this unique and sensitive sector and I look forward to following the success of the business."

Steven Rapley - International Trade Advisor at DIT



"Beautiful pools and wonderful to see the history of their development. Thank you for all you have done and designed for women, their babies and partners over the last 30yrs to make birth more comfortable and peaceful."

Amanda Edwards – midwife and active birth teacher.



"Biomedic International has been dealing with Mr Keith Brainin for more than 10 years as a distributor in UAE. He is a dedicated and trustworthy business partner with strong business ethics. He has been consistent in manufacturing and delivering quality birthing pools with great standards. His commitment to his promises are second to none. His attitude towards his business and his partners is remarkable. Moreover he is a great human being. Its been a great pleasure knowing Mr Keith as a business partner and as a friend."

Binu George Varghese - Managing Director - Biomedic International



"I have had the pleasure of working with Keith Brainin since 1985. His expertise in birth pools is unparalleled. He is professional to work with and the high standard of the birth pools has resulted in them withstanding the test of time and many births"

Yehudi Gordon MB BCh, MD, FRCOG, FCOG SA Author, water birth pioneer

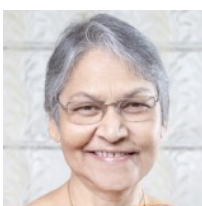

"When we introduced water birth and hydrotherapy in 2017 as options for women at Fernandez Hospital, our first Birth Pool and second one later- were both from Active Birth Pools. We've had no cause for regret. As an obstetrician, I actively promote hydrotherapy as a choice for pain relief and of course birth in water with midwifery-led care. Thank you, Keith Brainin for getting us started on this journey."

Evita Fernandez FRCOG (Fellow of the Royal College of Obs & Gyn, Chairperson, Fernandez Foundation; Natural Birthing and Midwifery champion

References and Testimonials



"It's my absolute pleasure to recommend Keith Brainin from Active Birth Pools. Keith and I have had a business relationship since 2015. His knowledge and expertise in waterbirth pools is outstanding. With over 35 years of experience within the industry, Keith has developed the highest standard birth pools on the market. Active Birth Pools are second to none. I thoroughly enjoy working with Keith and know him as a valuable asset to our company."

Jane Palmer Private midwife, lactation consultant and educator



"Brilliant, like the wide rims so mums can sit on the side and swivel their legs round to get in and out, much safer."

A. Bentley NHS Midwife



"I have worked intensely with Keith when we developed a birthing bed together. Keith knows what he wants and needs and can define if a product meets the endusers' criteria or not. He is very creative operates at a high standard. He is very straight and a deal is a deal. He knows the market and stays on top of new developments to keep his products at the highest possible standard."

Tom Smit Export manager at Score BV



"Even birth pools do not always permit free movement. Some pools are elaborate constructions with seats, handgrips and foot-rests. Movement in them is restricted, whereas Keith's pools allow mothers to move freely to find the most beneficial positions"

Sheila Kitzinger MBE – author and childbirth activist



"GM Medical have worked with Keith for several years with great success. Keith and his company have a portfolio of high quality products and an understanding of good partnership, which we highly appreciated over the years. Besides he is a great fun :-)"

Jesper Anker Fremming - CEO at GM MEDICAL A/S

References and Testimonials



"We've had the Venus since 2016 and we can highly recommend Keith and his pool. Keith has been always quick, helpful and kind in responding to any queries we've had and our mums and dads are very happy in using this pool! Thank you Keith!"

Catherine Verrecchia - Sage-femme coordinatrice, Centre Hospitalier Annecy



"Your water birth pools have revolutionised birth"

C. Wilson Senior Midwife, Dewsbury District Hospital

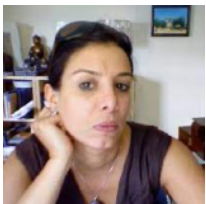

"I've used Active Birth pools for over 17 years. They're really beautiful, technically perfect and exceptionally easy to use."

Dr Lucia Rocca-Ihenacho PhD, MSc, RM – Lecturer in Midwifery



"Let me introduce you to Keith Brainin who provided us with water birth pools for both our birth centres. His pools are brilliant and the service he provides is excellent"

Dr Tracey Cooper MBE

Chief Midwife for the North East and Yorkshire at NHS England



"You clearly have a tub that is far superior to all the tubs we have found, not only for patient comfort, but also for provider convenience".

Karen Werrbach MSN, RNC-OB, NEA-BC



mothers & midwives



love our water birth pools

Our core principles of Safety, Value & Performance makes

If you're looking for a water birth pool we're uniquely qualified to be of service.

Long established as the benchmark standard our new pools are a quantum leap forward in every respect

For more information:

Active Birth Pools est. 1987
+44 (0) 7793 745907
www.activebirthpools.com

